



胰臟癌診療指引

Pancreatic Adenocarcinoma

胰臟癌診療指引

一、參與討論同仁

主席	蔡坤志醫師 (消化內科)	
附設醫院	高偉育醫師 (消化內科)	李欣倫醫師 (放射腫瘤科)
	林家伶個管師 (癌症中心)	
萬芳醫院	張智翔醫師 (消化內科)	廖子堯醫師 (血液腫瘤科)
	余信賢醫師 (一般外科)	胡瑾瑜個管師 (癌症中心)
雙和醫院	謝耀宇醫師 (血液腫瘤科)	胡炳任醫師 (消化內科)
	詹謹怡個管師 (癌症中心)	

二、討論日期：112年12月13日

三、校稿人員：張智翔醫師 / 胡瑾瑜個管師

113 年版與上一版差異：

112 年修訂版	113 年修訂版
《胰臟癌診療指引共識 -1》 檢查→影像中有腫瘤→無轉移→ 其中「內視鏡超音波 EUS± 切片」	修改為 「考慮內視鏡超音波 EUS± 切片」
《胰臟癌診療指引共識 -1》 檢查→影像中無腫瘤→轉移→自轉移處行切片→	後面路徑新增 轉移性疾病 (指引 -8)
《胰臟癌診療指引共識 -7、8、9》 內文中的「全身性化學治療」	皆修改為 「全身性藥物治療」

Work Up

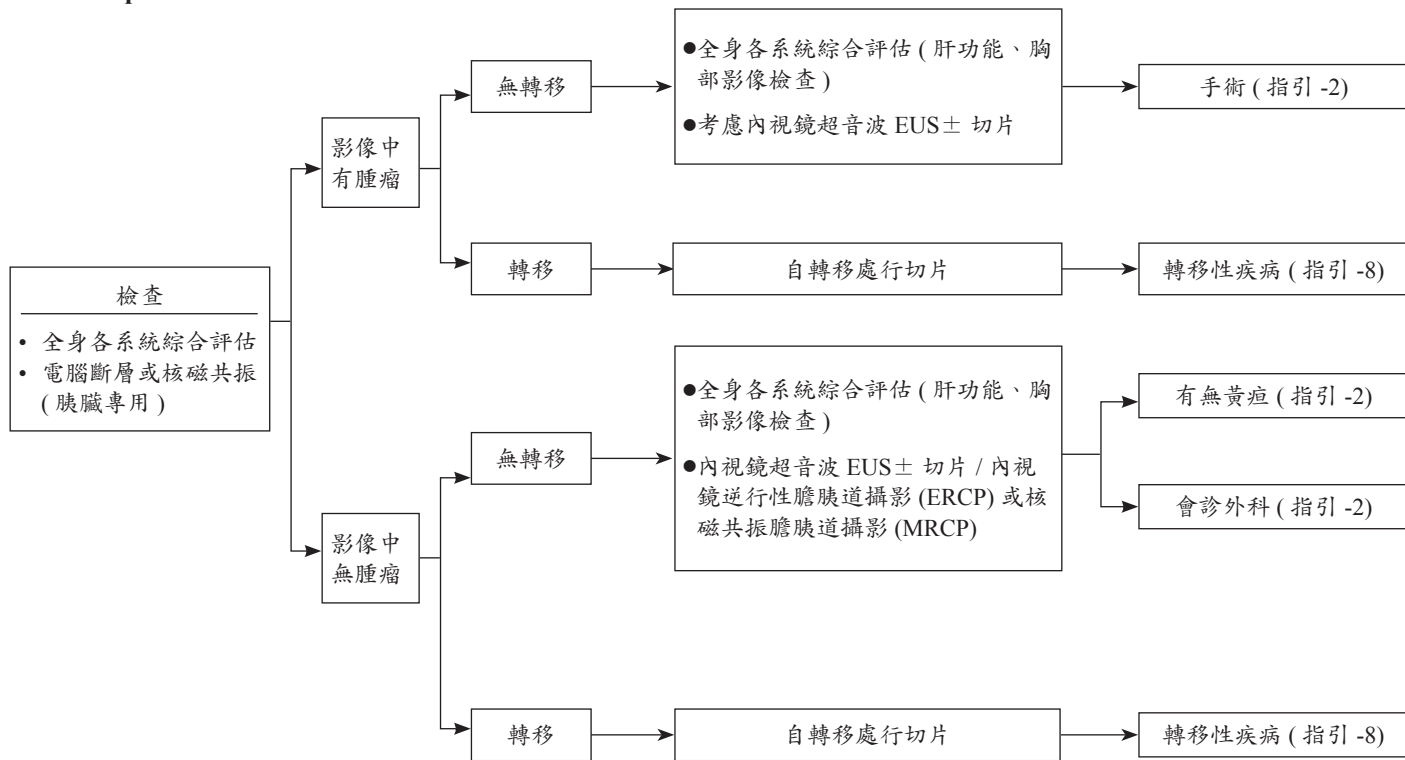

《胰臟癌診療指引 - 2》

Work Up

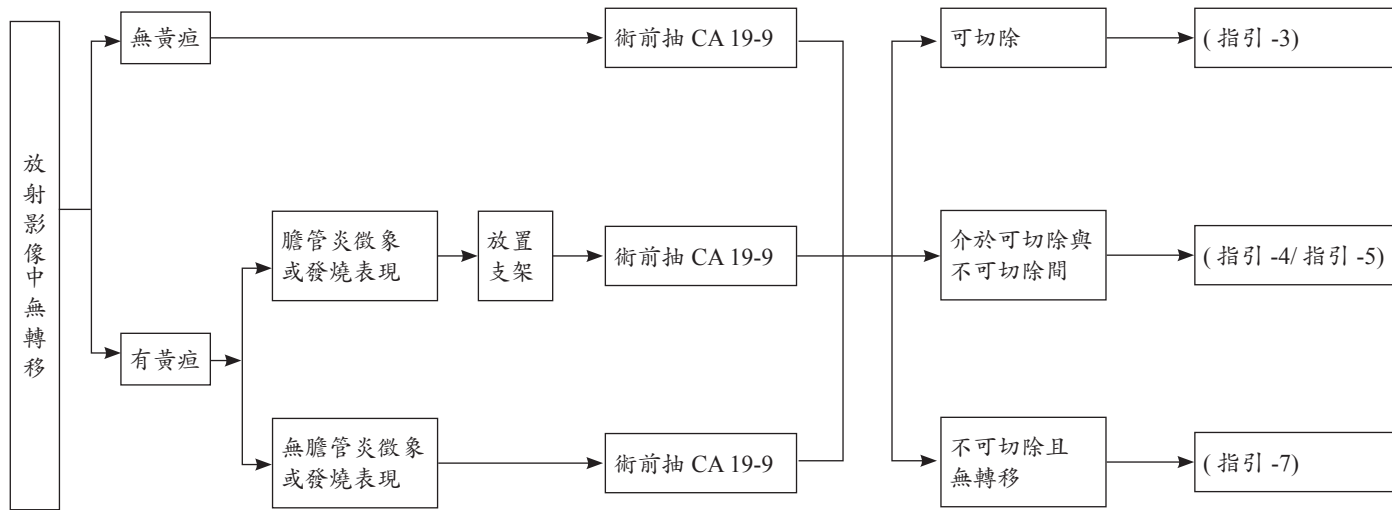

- RESECTABLE
- BORDERLINE RESECTABLE NO METASTASES, PLANNED NEOADJUVANT THERAPY
- BORDERLINE RESECTABLE NO METASTASES, PLANNED RESECTION.

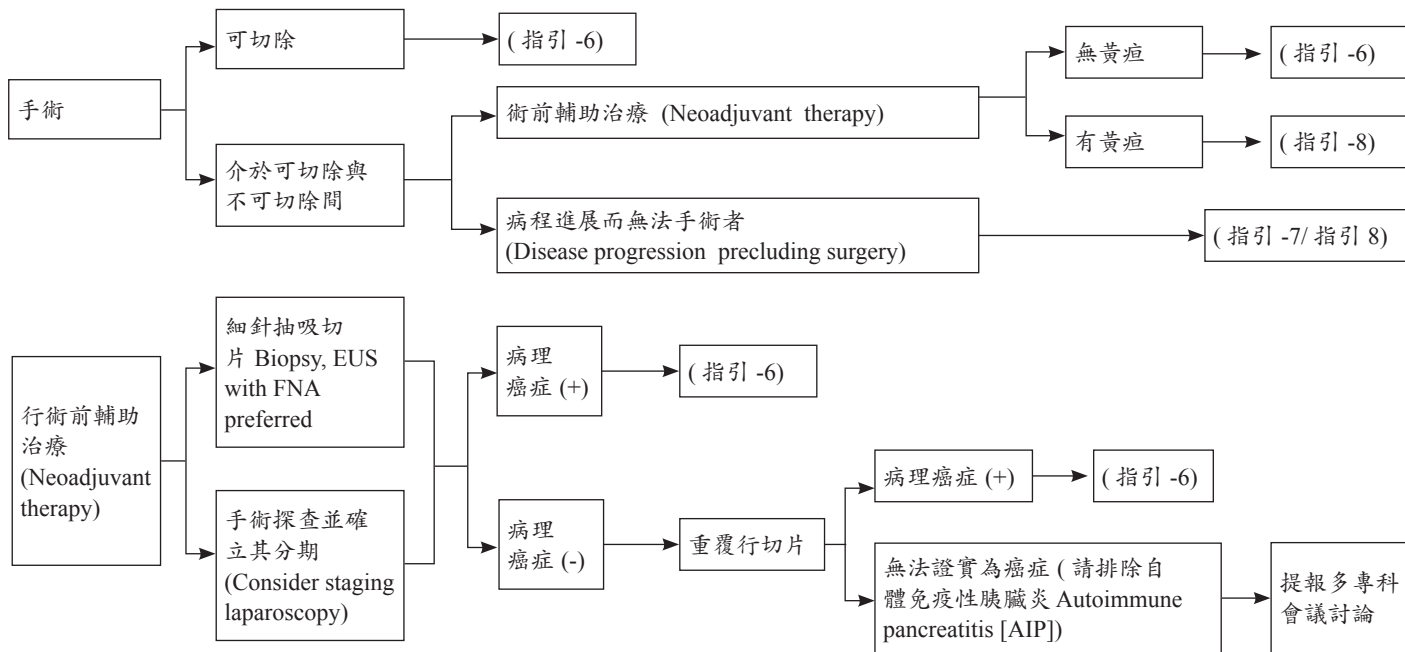

《胰臟癌診療指引 - 6》

POST-OP ADJUVANT TREATMENT

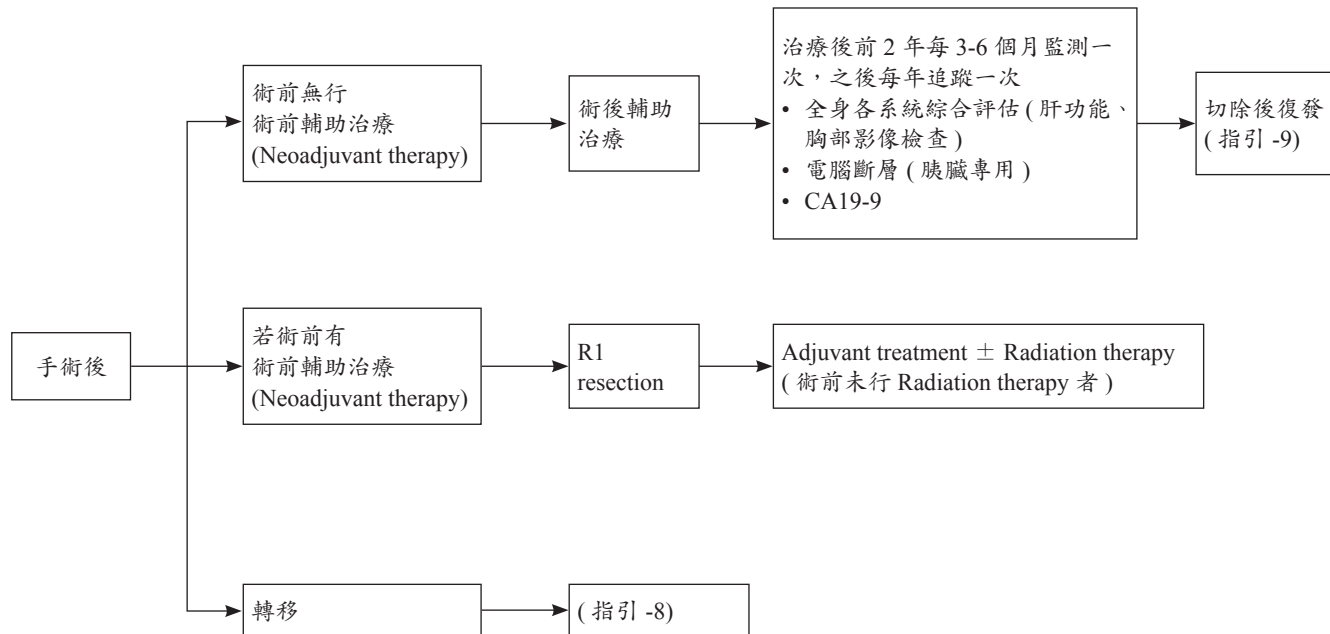

LOCALLY ADVANCED UNRESECTABLE

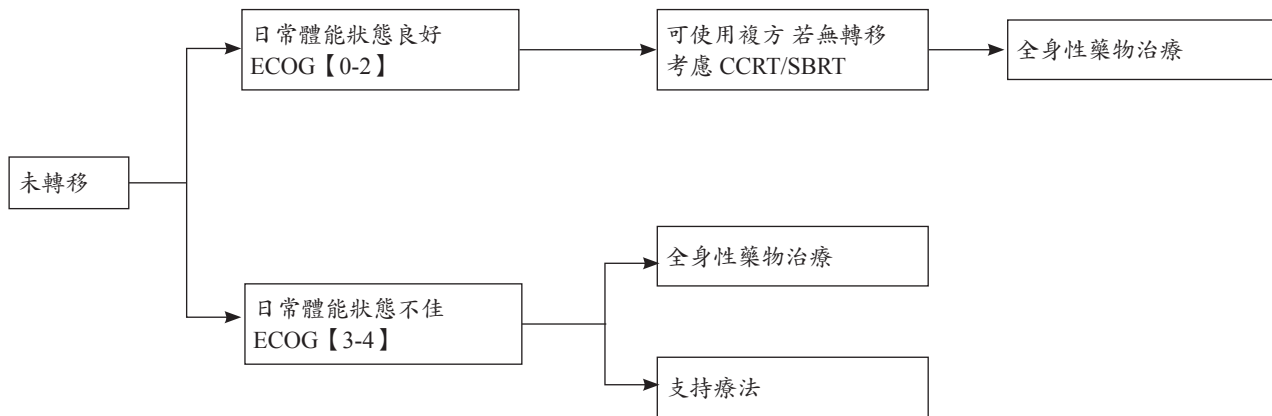

《胰臟癌診療指引 - 8》

METASTATIC DISEASE

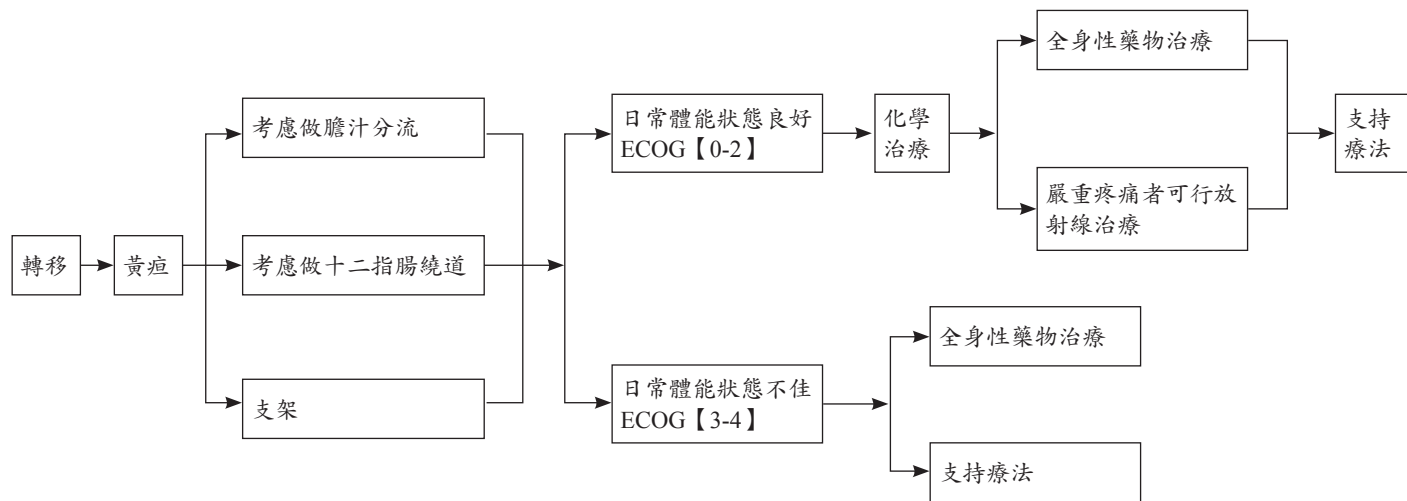

RECURRENCE AFTER RESECTION

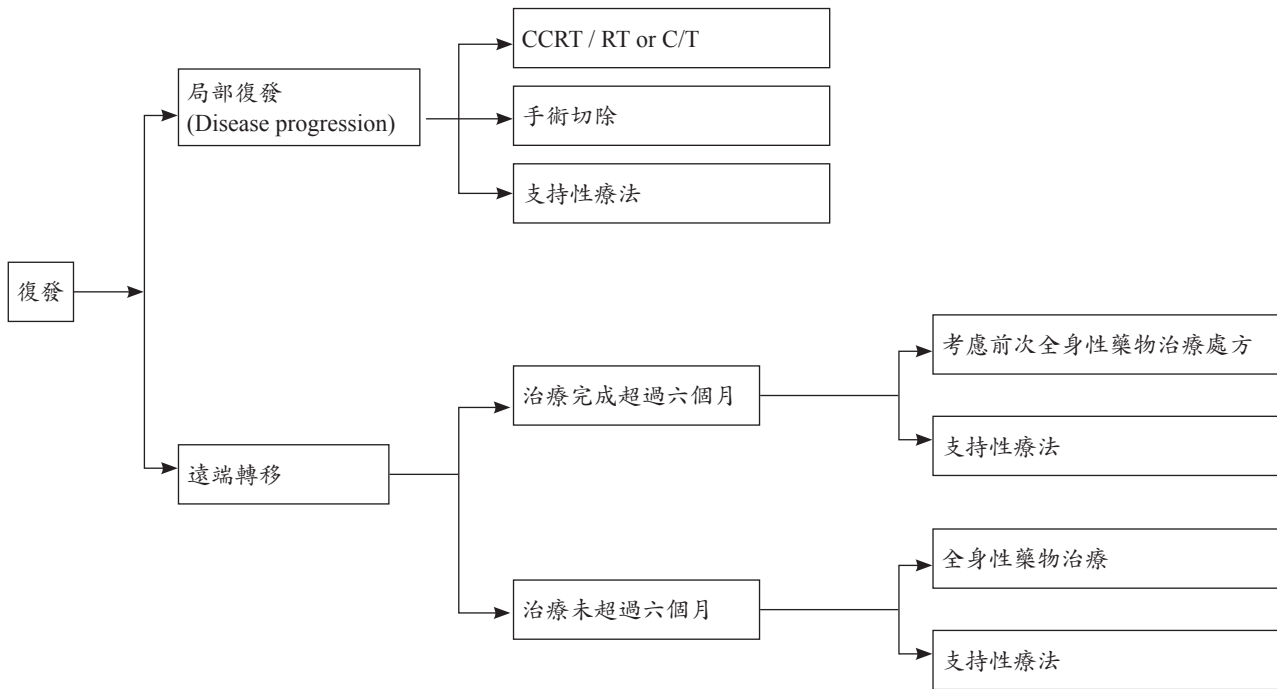

《參考文獻》

1. NCCN Clinical Practice Guidelines in Oncology: Pancreatic Adenocarcinoma Version 2.2023.
2. Mornex F, Girard N, Delpero J-R, Partensky C. Radiochemotherapy in the management of pancreatic cancer –part I: neoadjuvant treatment. *Semin Radiat Oncol* 2005;15:226-234
3. Bickenbach KA, Gonen M, Tang LH, et al. Downstaging in pancreatic cancer: a matched analysis of patients resected following treatment of initially locally unresectable disease. *Ann Surg Oncol* 2012;19:1663-1669.
4. Mondo EL, Noel MS, Katz W, ET AL. unresectable locally advanced pancreatic cancer: treatment with neoadjuvant leucovorin, fluorouracil, irinotecan, and oxaliplatin and assessment of surgical resectability. *J Clin Oncol* 2013;31:e37- 39.
5. Tempero MA, Berlin J, Ducreux M, et al pancreatic cancer treatment and research: an international expert panel discussion. *Ann Oncol* 2011;22:1500-1506.
6. Seiwert TY, Salama TY, Salama JK, Vokes EE. The concurrent chemoradiation paradigm—general principles. *Nat Clin Pract Oncol* 2007;4:86-100.
7. Girard N, Mornex F, Bossard N, et al estimating optimal dose of twice –weekly gemcitabine for concurrent chemoradiotherapy in unresectable pancreatic carcinoma: mature results of GEMRT-01 phase I trial. *Int J Radiat Oncol Biol Phys* 2010;77:1426-1432.
8. Murphy JD, Adusumilli S, Griffith KA, et al Full-dose gemcitabine and concurrent radiotherapy for unresectable pancreatic cancer. *Int J Radiat Oncol Biol Phys* 2007;68:801-808
9. Ammori JB, Colletti LM, Zalupski MM, et al. Surgical resection following radiation therapy with concurrent gemcitabine in patients with previously unresectable adenocarcinoma of the pancreas. *J Gastrointest Surg* 2003;7:766-772.
10. Marti JL, Hochster HS, Hiotis SP, et al. Phase I/II trial of induction chemotherapy followed by concurrent chemoradiotherapy and surgery for locoregionally advanced pancreatic cancer. *Ann Surg Oncol* 2008;15:3521-3531.
11. Van Buren G, 2nd, Ramanathan RK, Krasinskas AM, et al. Phase II study of induction fixed-dose rate gemcitabine and bevacizumab followed by 30 Gy radiotherapy as preoperative treatment for potentially resectable pancreatic adenocarcinoma. *Ann Surg Oncol* 2013;20:3787-3793

《胰臟癌抗癌藥物治療指引》

Neoadjuvant Chemotherapy

FOLFIRINOX

藥品名	劑量 mg/m ²	給藥日	頻率	週期	參考文獻
Irinotecan	180	1	Q2W	4	1
Oxaliplatin	85	1	Q2W	4	
Leucovorin	400	1	Q2W	4	
5-FU	400	1	Q2W	4	
5-FU	1200	1-2	Q2W	4	

modified FOLFIRINOX

藥品名	劑量 mg/m ²	給藥日	頻率	週期	參考文獻
Irinotecan	150*	1	Q2W	4	2
Oxaliplatin	85	1	Q2W	4	
Leucovorin	400	1	Q2W	4	
5-FU	1200	1-2	Q2W	4	

* 團隊共識

Gemcitabine + Nab Paclitaxel

藥品名	劑量 mg/m ²	給藥日	頻率	週期	參考文獻
Gemcitabine	1000	1, 8, 15	Q4W	2-4	3
Nab-Paclitaxel	125	1, 8, 15	Q4W	2-4	

Only for known BRCA 1/2 or PALB2 mutation**Gemcitabine + Cisplatin**

藥品名	劑量 mg/m ²	給藥日	頻率	週期	參考文獻
Gemcitabine	1000	1, 15	Q4W	2-6	4
Cisplatin	50	1, 15	Q4W	2-6	

Adjuvant Chemotherapy**Preferred regimen****modified FOLFIRINOX**

藥品名	劑量 mg/m ²	給藥日	頻率	週期	參考文獻
Irinotecan	150	1	Q2W	12	5
Oxaliplatin	85	1	Q2W	12	
Leucovorin	400	1	Q2W	12	
5-FU	1200	1-2	Q2W	12	

Gemcitabine + Capecitabine

藥品名	劑量 mg/m ²	給藥日	頻率	週期	參考文獻
Gemcitabine	1000	1, 8, 5	Q4W	6	6
Capecitabine	750-1000* PO BID	1-21	Q4W	6	

* 團隊共識

Other Recommended Regimen

Gemcitabine

藥品名	劑量 mg/m ²	給藥日	頻率	週期	參考文獻
Gemcitabine	1000	1, 8, 15	Q4W	6	6

5 Fu + Leucovorin

藥品名	劑量 mg/m ²	給藥日	頻率	週期	參考文獻
Leucovorin	20	1-5	Q4W	6	7
5-FU	425	1-5	Q4W	6	

Capecitabine

藥品名 [*]	劑量 mg/m ²	給藥日	頻率	週期	參考文獻
Capecitabine	1000 PO BID	1-14	Q3W	8	8

Induction chemotherapy followed by chemoradiation

Gemcitabine based

藥品名	劑量 mg/m ²	給藥日	頻率	週期	參考文獻
Gemcitabine	1000	1, 8, 15	Q4W	2-6	9

5Fu + Leucovorin based

藥品名	劑量 mg/m ²	給藥日	頻率	週期	參考文獻
Leucovorin	20	1-5	Q4W	6	9
5-Fu	425	1-5	Q4W	6	

Induction chemotherapy followed by chemoradiation followed by subsequent chemotherapy**Gemcitabine based**

藥品名	劑量 mg/m ²	給藥日	頻率	週期	參考文獻
Gemcitabine	1000	1, 8, 15	Q4-6W	1	10
Followed by radiation		29			
Gemcitabine	1000	1, 8, 15	Q4W	3-5	

5Fu + Leucovorin based

藥品名	劑量 mg/m ²	給藥日	頻率	週期	參考文獻
Leucovorin	20	1-5	Q4W	1	10
5-Fu	425	1-5	Q4W	1	
Followed by CCRT					
Leucovorin	20	1-5	Q4W	3	
5-Fu	425	1-5	Q4W	3	

參考文獻

1. Murphy JE, Wo JY, Ryan DP, et al. Total Neoadjuvant Therapy With FOLFIRINOX Followed by Individualized Chemoradiotherapy for Borderline Resectable Pancreatic Adenocarcinoma: A Phase 2 Clinical Trial. JAMA Oncol. 2018; 4:963-969.

2. Nanda RH, El-Rayes B, Maithel SK, et al. Neoadjuvant modified FOLFIRINOX and chemoradiation therapy for locally advanced pancreatic cancer improves resectability. *J Surg Oncol*. 2015;111:1028-34.
3. Miyashita T, Tajima H, Makino I, et al. Neoadjuvant Chemotherapy with Gemcitabine Plus Nab-paclitaxel Reduces the Number of Cancer-associated Fibroblasts Through Depletion of Pancreatic Stroma. *Anticancer Res*. 2018; 38:337-343.
4. Oliver GR, Sugar E, Laheru D, et al. Family history of cancer and sensitivity to platinum chemotherapy in pancreatic adenocarcinoma. 2010 Gastrointestinal Cancers Symposium. Abstract No. 151.
5. Conroy T, Hammel P, Hebbar M, et al. FOLFIRINOX or Gemcitabine as Adjuvant Therapy for Pancreatic Cancer. *N Engl J Med* 2018;379:2395-2406.
6. Neoptolemos JP, Palmer DH, Ghaneh P, et al. Comparison of adjuvant gemcitabine and capecitabine with gemcitabine monotherapy in patients with resected pancreatic cancer (ESPAC-4): a multicentre, open-label, randomised, phase 3 trial. *Lancet*. 2017;389:1011-1024.
7. Neoptolemos JP, Moore MJ, Cox TF, et al. Effect of adjuvant chemotherapy with fluorouracil plus folinic acid or gemcitabine vs observation on survival in patients with resected periampullary adenocarcinoma: the ESPAC-3 periampullary cancer randomized trial. *JAMA*. 2012;308:147-56.
8. Cartwright TH, Cohn A, Varkey JA, et al. Phase II study of oral capecitabine in patients with advanced or metastatic pancreatic cancer. *J Clin Oncol* 2002;20:160-164.
9. Regine WF, Winter KA, Abrams RA, et al. Fluorouracil vs. gemcitabine chemotherapy before and after fluorouracil-based chemoradiation following resection of pancreatic adenocarcinoma. a randomized controlled trial. *JAMA* 2008; 299:1019-1026.
10. Schellenberg D, Kim J, Christman-Skieller C, Chun CL, et al. Single-fraction stereotactic body radiation therapy and sequential gemcitabine for the treatment of locally advanced pancreatic cancer. *Int J Radiat Oncol Biol Phys*. 2011 Sep 1;81(1):181-8.

Locally Advanced or Metastatic Disease

First line therapy

Good PS 0-1

Preferred regimen

FOLFIRINOX

藥品名	劑量 mg/m ²	給藥日	頻率	週期	參考文獻
Irinotecan	180	1	Q2W	12	2
Oxaliplatin	85	1	Q2W	12	
Leucovorin	400	1	Q2W	12	
5-FU	400	1	Q2W	12	
5-FU	1200	1-2	Q2W	12	

modified FOLFIRINOX

藥品名	劑量 mg/m ²	給藥日	頻率	週期	參考文獻
Irinotecan	150*	1	Q2W	2-8	2
Oxaliplatin	85	1	Q2W	2-8	
Leucovorin	400	1	Q2W	2-8	
5-FU	1200	1-2	Q2W	2-8	

* 團隊共識

Gemcitabine + Nab Paclitaxel

藥品名	劑量 mg/m ²	給藥日	頻率	週期	參考文獻
Gemcitabine	1000	1, 8, 15	Q4W		3
Nab-Paclitaxel	125	1, 8, 15	Q4W		

Only for known BRCA 1/2 or PALB2 mutation

Gemcitabine + Cisplatin

藥品名 [*]	劑量 mg/m ²	給藥日	頻率	週期	參考文獻
Gemcitabine	1000	1, 15	Q4W		1
Cisplatin	50	1, 15	Q4W		
Followed by ± Olaparib	300 mg PO BID				10

Other Recommended Regimen

Gemcitabine + Erlotinib

藥品名 [*]	劑量 mg/m ²	給藥日	頻率	週期	參考文獻
Gemcitabine	1000	1, 8, 15	Q4W		4
Erlotinib	100-150 mg	1-28	Q4W		

Gemcitabine

藥品名	劑量 mg/m ²	給藥日	頻率	週期	參考文獻
Gemcitabine	1000	1, 8, 15	Q4W		5

Gemcitabine + Capecitabine

藥品名*	劑量 mg/m ²	給藥日	頻率	週期	參考文獻
Gemcitabine	1000	1, 8, 15	Q4W		15
Capecitabine	830 BID PO	1-21	Q4W		

Capecitabine (not for metastatic disease)

藥品名*	劑量 mg/m ²	給藥日	頻率	週期	參考文獻
Capecitabine	1000 BID PO	1-21	Q4W		14

Fix-dose-rate Gemcitabine, Docetaxel, Capecitabine (GTX)

藥品名*	劑量 mg/m ²	給藥日	頻率	週期	參考文獻
Gemcitabine	750*	1	Q3W		16
Docetaxel	30	4, 11	Q3W		
Capecitabine	750 BID PO	1-14	Q3W		

*infusion over 75 min

Gemcitabine + Nab-Paclitaxel + Cisplatin

藥品名*	劑量 mg/m ²	給藥日	頻率	週期	參考文獻
Gemcitabine	1000	1, 8	Q3W		17, 18
Nab-Paclitaxel	125	1, 8	Q3W		
Cisplatin	25	1, 9	Q3W		

CapeOx (≤ 65 years, ECOG 0-1)

藥品名*	劑量 mg/m ²	給藥日	頻率	週期	參考文獻
Oxaliplatin	130	1	Q3W		16
Capecitabine	1000 BID PO	1-14	Q3W		

CapeOx (> 65 years or ECOG 2)

藥品名*	劑量 mg/m ²	給藥日	頻率	週期	參考文獻
Oxaliplatin	110	1	Q3W		16
Capecitabine	750 BID PO	1-14	Q3W		

NALIRIFOX

藥品名*	劑量 mg/m ²	給藥日	頻率	週期	參考文獻
Liposomal Irinotecan	50	1	Q2W		20
Oxaliplatin	60	1	Q2W		
Leucovorin	400	1	Q2W		
5-FU	1200	1, 2	Q2W		

Intermediate PS 2

Capecitabine (not for metastatic disease)

藥品名*	劑量 mg/m ²	給藥日	頻率	週期	參考文獻
Capecitabine	1000 BID PO	1-21	Q4W		14

Gemcitabine

藥品名	劑量 mg/m ²	給藥日	頻率	週期	參考文獻
Gemcitabine	1000	1, 8, 15	Q4W		5

Gemcitabine + Nab Paclitaxel

藥品名	劑量 mg/m ²	給藥日	頻率	週期	參考文獻
Gemcitabine	1000	1, 8, 15	Q4W	2-4	21
Nab-Paclitaxel	125	1, 8, 15	Q4W	2-4	

NALIRIFOX

藥品名*	劑量 mg/m ²	給藥日	頻率	週期	參考文獻
Liposomal Irinotecan	50	1	Q2W		20
Oxaliplatin	60	1	Q2W		
Leucovorin	400	1	Q2W		
5-FU	1200	1, 2	Q2W		

Not list in NCCN**GOLF**

藥品名*	劑量 mg/m ²	給藥日	頻率	週期	參考文獻
Gemcitabine	1000	1	Q2W		9
Oxaliplatin	85	1	Q2W		
Leucovorin	120	1	Q2W		
5-FU	1200	1-2	Q2W		

SOLG

藥品名*	劑量 mg/m ²	給藥日	頻率	週期	參考文獻
Gemcitabine	800	1	Q2W		13
Oxaliplatin	85	1	Q2W		
Leucovorin	20 PO BID	1-7	Q2W		
TS-1	20-40 PO BID	1-7	Q2W		

TS-1

藥品名*	劑量 mg/m ²	給藥日	頻率	週期	參考文獻
TS-1	80-120 PO	1-28 (1-14)	Q6W (Q3W)		6

Poor PS 3-4

Preferred regimen

Gemcitabine

藥品名*	劑量 mg/m ²	給藥日	頻率	週期	參考文獻
Gemcitabine	1000	1, 8, 15	Q4W		5

Fix-dose-rate Gemcitabine

藥品名*	劑量 mg/m ²	給藥日	頻率	週期	參考文獻
Gemcitabine	1000*	1, 8, 15	Q4W		7

*Flow rate: 10mg/m²/min

Metastatic, useful in certain circumstances

Pembrolizumab

藥品名*	劑量 mg/m ²	給藥日	頻率	週期	參考文獻
Pembrolizumab	200 mg	1	Q3W		8

Larotrectinib NTRK gene dusion positive

藥品名*	劑量 mg/m ²	給藥日	頻率	週期	參考文獻
Larotrectinib	100 mg PO BID	1			11

Entrectinib NTRK gene dusion positive

藥品名*	劑量 mg/m ²	給藥日	頻率	週期	參考文獻
Entrectinib	600 mg PO QD	1			12

Dabrafenib + Trametinib BRAF V600E mutation positive

藥品名*	劑量 mg/m ²	給藥日	頻率	週期	參考文獻
Dabrafenib	150 mg PO BID	1			22, 23
Trametinib	2 mg PO QD	1			

Metastatic Disease (maintenance therapy)

Prior platinum-based therapy:

Rucaparib (for germline or somatic BRCA1/2 or PALB2 mutations)

藥品名*	劑量 mg/m ²	給藥日	頻率	週期	參考文獻
Rucaparib	600 mg PO BID	1			19

*For patients who did not have disease progression following their most recent platinum-based chemotherapy

參考文獻

- 1 Oliver GR, Sugar E, Laheru D, et al. Family history of cancer and sensitivity to platinum chemotherapy in pancreatic adenocarcinoma. 2010 Gastrointestinal Cancers Symposium. Abstract No. 151.
2. Conroy T, Desseigne F, Ychou M, et al. FOLFIRINOX versus gemcitabine for metastatic pancreatic cancer. N Engl J Med 2011;364:1817-25.
3. Von Hoff DD, Ervin T, Arena FP, et al. Increased survival in pancreatic cancer with nab-paclitaxel plus gemcitabine. N Engl J Med 2013;369:1691-703.
4. Moore MJ, Goldstein D, Hamm J, et al. Erlotinib plus gemcitabine compared with gemcitabine alone in patients with advanced pancreatic cancer: a phase III trial of the National Cancer Institute of Canada Clinical Trials Group. J Clin Oncol. 2007;25:1960-6.
5. Burris HA 3rd, Moore MJ, Andersen J, et al. Improvements in survival and clinical benefit with gemcitabine as first-line therapy for patients with advanced pancreas cancer: a randomized trial. J Clin Oncol. 1997;15:2403-13.
6. Ueno H, Ioka T, Ikeda M, et al. Randomized phase III study of gemcitabine plus S-1, S-1 alone, or gemcitabine alone in patients with locally advanced and metastatic pancreatic cancer in Japan and Taiwan: GEST study. J Clin Oncol. 2013;31:1640-8.

7. Gelibter A, Malaguti P, Di Cosimo S, et al. Fixed dose-rate gemcitabine infusion as first-line treatment for advanced-stage carcinoma of the pancreas and biliary tree. *Cancer*. 2005;104:1237-45.
8. Marabelle A, Le DT, Ascierto PA, et al. Efficacy of Pembrolizumab in Patients With Noncolorectal High Microsatellite Instability/Mismatch Repair-Deficient Cancer: Results From the Phase II KEYNOTE-158 Study. *J Clin Oncol*. 2020;38:1-10.
9. Gill S, Ko YJ, Cripps C, et al. PANCREOX: a randomized phase III study of 5-fluorouracil/leucovorin with or without oxaliplatin for second-line advanced pancreatic cancer in patients who have received gemcitabine-based chemotherapy. *J Clin Oncol*. 2016; 34: 3914–3920.
10. Golan T, Hammel P, Reni M, et al. Maintenance Olaparib for Germline BRCA-Mutated Metastatic Pancreatic Cancer. *N Engl J Med*. 2019;381:317-327.
11. Product Information: VITRAKVI(R) oral capsules, oral solution, larotrectinib oral capsules, oral solution. Loxo Oncology Inc (per FDA), Stamford, CT, 2018.
12. Product Information: ROZLYTREK(TM) oral capsules, entrectinib oral capsules. Genentech Inc (per FDA), South San Francisco, CA, 2019.
13. Chiang NJ, Tsai KK, Hsiao CF, et al. A multicenter, phase I/II trial of biweekly S-1, leucovorin, oxaliplatin and gemcitabine in metastatic pancreatic adenocarcinoma-TCOG T1211 study. *Eur J Cancer*. 2020 Jan;124:123-130.
14. Cartwright TH, Cohn A, Varkey JA, et al. Phase II study of oral capecitabine in patients with advanced or metastatic pancreatic cancer. *J Clin Oncol* 2002;20:160-164.
15. Cunningham D, Chau I, Stocken DD, et al. Phase III randomized comparison of gemcitabine (GEM) versus gemcitabine plus capecitabine (GEM-CAP) in patients with advanced pancreatic cancer. *J Clin Oncol* 2009;27:5513-5518.
16. Fine RL, Fogelman DR, Schreiber SM, et al. The gemcitabine, docetaxel, and capecitabine (GTX) regimen for metastatic pancreatic cancer: a retrospective analysis. *Cancer Chemother Pharmacol* 2008;61:167-175.
17. Jameson GS, Borazanci E, Babiker HM, et al. Response rate following albuminbound paclitaxel plus gemcitabine plus cisplatin treatment among patients with advanced pancreatic cancer: A phase 1b/2 pilot clinical trial [published online ahead of print,

- 2019 Oct 3] [published correction appears in JAMA Oncol 2019;5:1643]. JAMA Oncol 2019;6:125-132.
18. Shroff RT, Javle MM, Xiao L, et al. Gemcitabine, cisplatin, and nab-paclitaxel for the treatment of advanced biliary tract cancers: A phase 2 clinical trial. JAMA Oncol 2019;5:824-830.
 19. Reiss KA, Mick R, O'Hara MH, et al. Phase II study of maintenance rucaparib in patients with platinum-sensitive advanced pancreatic cancer and a pathogenic germline or somatic variant in BRCA1, BRCA2, or PALB2. J Clin Oncol 2021;39:2497-2505.
 20. Wainberg Z, Bekai-Saab T, Boland P, et al. First-line liposomal irinotecan with oxaliplatin, 5-fluorouracil and leucovorin (NALIRIFOX) in pancreatic ductal adenocarcinoma: A phase I/II study. Eur J Cancer. 2021 Jul;151:14-24.
 21. Miyashita T, Tajima H, Makino I, et al. Neoadjuvant Chemotherapy with Gemcitabine Plus Nab-paclitaxel Reduces the Number of Cancer-associated Fibroblasts Through Depletion of Pancreatic Stroma. Anticancer Res. 2018; 38:337-343.
 22. Salama AKS, Li S, Macrae ER, et al. Dabrafenib and Trametinib in Patients With Tumors With BRAF V600E Mutations: Results of the NCI-MATCH Trial Subprotocol H. J Clin Oncol 2020;38:3895-3904.
 23. Subbiah V, Lassen U, Élez E, et al. Dabrafenib plus trametinib in patients with BRAFV600E-mutated biliary tract cancer (ROAR): a phase 2, open-label, singlearm, multicentre basket trial. Lancet Oncol. 2020;21:1234-1243.